

# SHOWER SEALS ONLINE



**PRODUCT  
PROFILE**

**CLAMPS**



Architectural glass  
fittings and bathroom  
accessories

We have a strong focus on developing new products and as a testament to our innovation, we boast one of the most diverse and unique inventories in our field.

## OUR EFFORTS ARE GUIDED BY THE FOLLOWING THREE PRINCIPLES

### VALUE

Providing our customers with the products they need at a good price is just the beginning. By choosing to deal with us, our customers must receive extra value. To this end we offer technical support, training and software aimed at making the jobs of our customers easier.

### SERVICE

Prompt delivery isn't enough. By choosing to deal with us, our customers have earned a partner that goes the extra mile. In this spirit, we respond to our customers needs irrespective of what we have in stock.

### QUALITY

Reliability is a given. By choosing to deal with us, our customers deserve an attention to detail. That is why we worry about the small things like superior fixings and high grade gaskets.

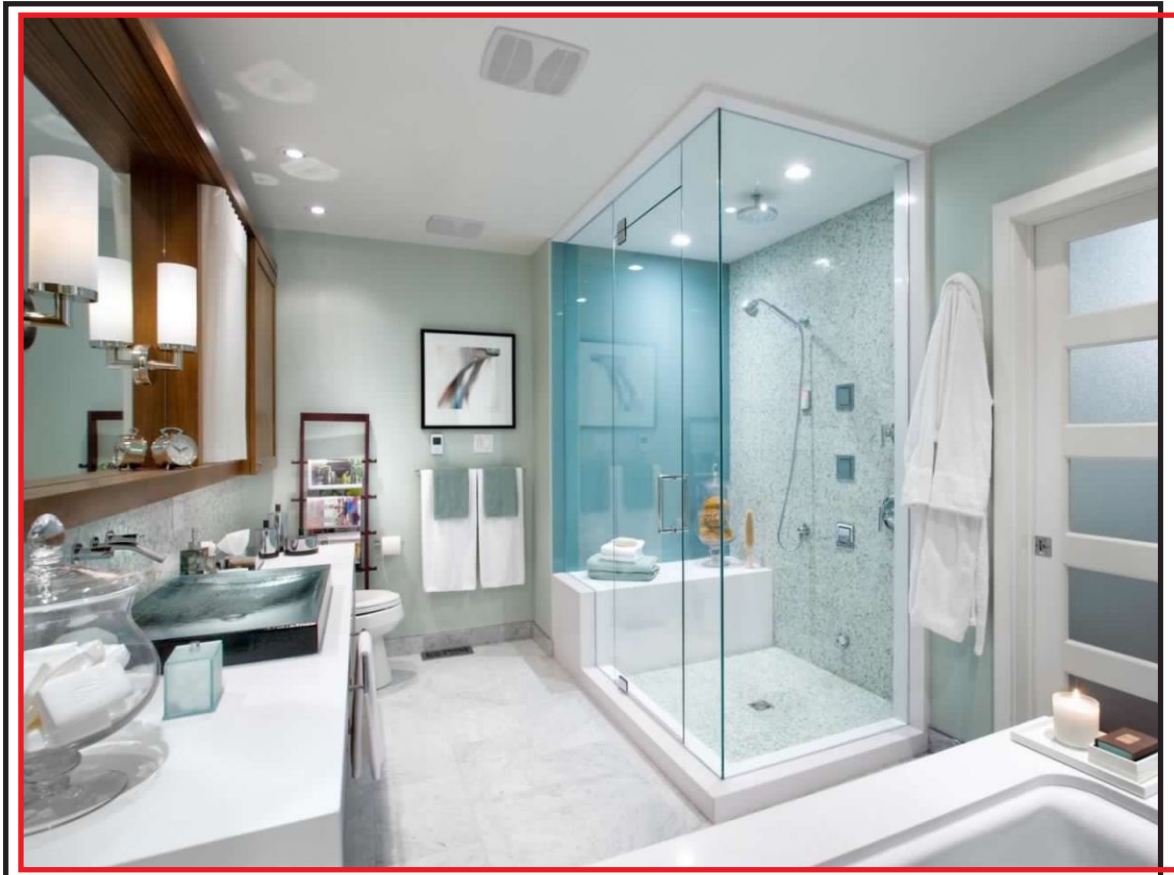

Our insistence on strength and durability is clearly evident in our designer chrome clamp range.

GC-801



Wall-to-glass clamp  
single fix  
Glass thickness: 6 to 12mm toughen safety glass  
Material: Brass  
Finish: Bright or satin chrome plated

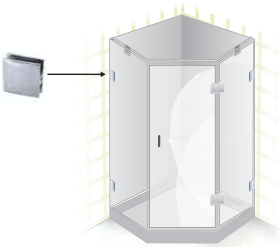

GLASS CUT-OUT      SLOT CUT-OUT

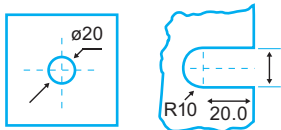

TOP VIEW

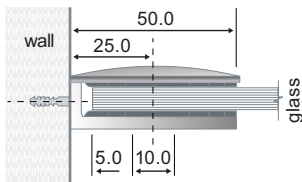

SIDE VIEW

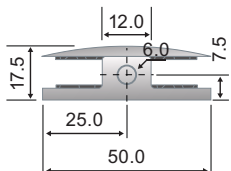

GC-801D



Wall-to-glass clamp  
double fix  
Glass thickness: 6 to 12mm toughen safety glass  
Material: Brass  
Finish: Bright chrome plated

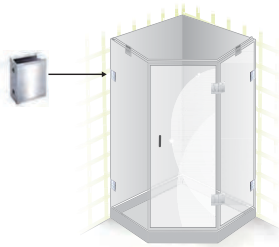

GLASS CUT-OUT      SLOT CUT-OUT

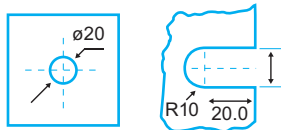

TOP VIEW

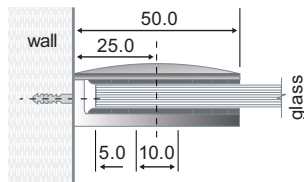

SIDE VIEW

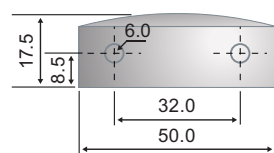

GC-802



90° Wall-to-glass clamp  
Glass thickness: 6 to 12mm toughen safety glass  
Material: Brass  
Finish: Bright or satin chrome plated

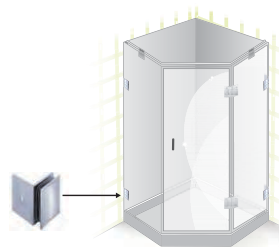

GLASS CUT-OUT      SLOT CUT-OUT

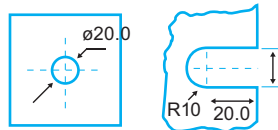

TOP VIEW

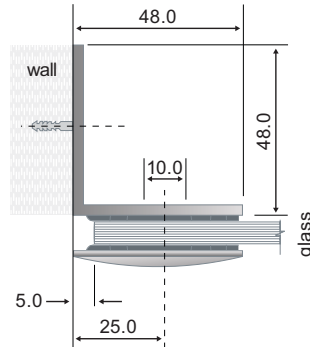

TOP VIEW

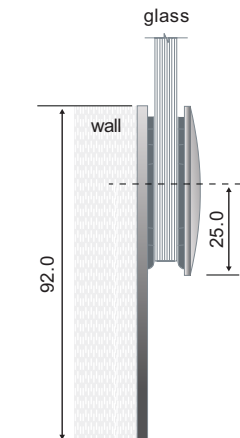

GC-803



180° Wall-to-glass clamp  
Glass thickness: 6 to 12mm toughen safety glass  
Material: Brass  
Finish: Bright or satin chrome plated

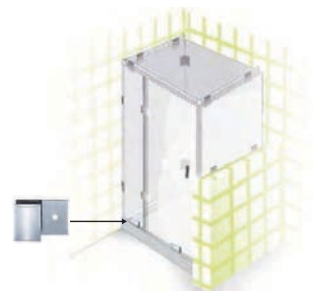

GLASS CUT-OUT      SLOT CUT-OUT

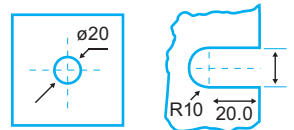

TOP VIEW

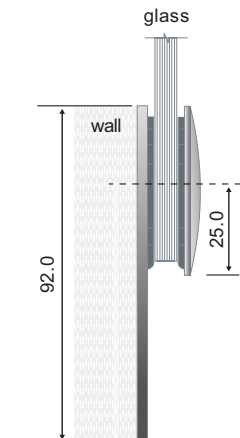

GC-804

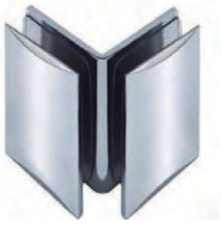

90° Glass-to-glass clamp  
Glass thickness: 6 to 12mm toughen safety glass  
Material: Brass  
Finish: Bright or satin chrome plated

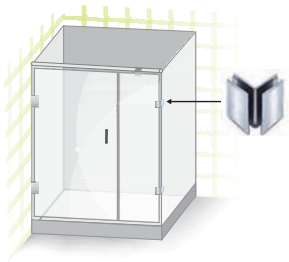

GLASS CUT-OUT



TOP VIEW

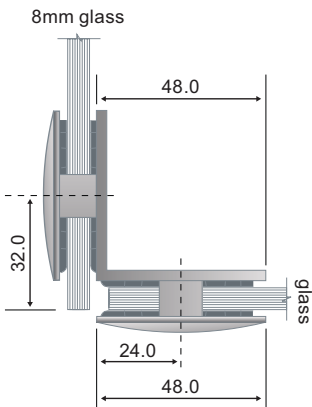

Deduction calculated for 8mm glass.

GC-805



135° Glass-to-glass clamp  
Glass thickness: 6 to 12mm toughen safety glass  
Material: Brass  
Finish: Bright or satin chrome plated

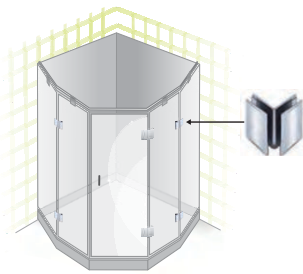

GLASS CUT-OUT



TOP VIEW

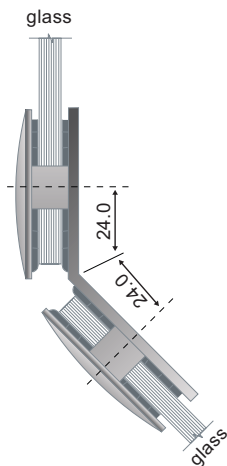

GC-806



180° Glass-to-glass clamp  
Glass thickness: 6 to 12mm toughen safety glass  
Material: Brass  
Finish: Bright or satin chrome plated

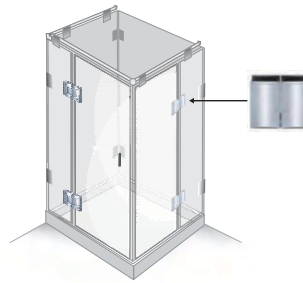

GLASS CUT-OUT



TOP VIEW

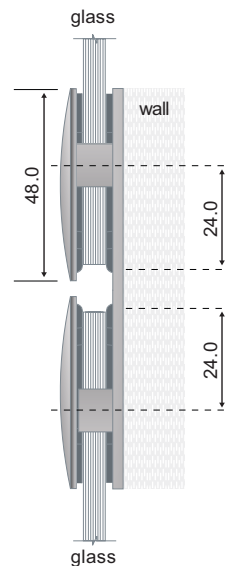

GC-807



90° Double tee clamp  
Glass thickness: 6 to 12mm toughen safety glass  
Material: Brass  
Finish: Bright or satin chrome plated

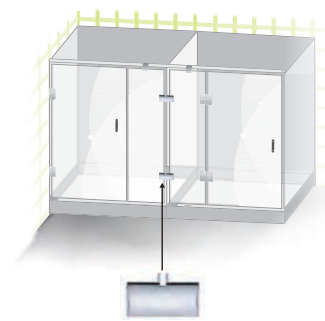

GLASS CUT-OUT

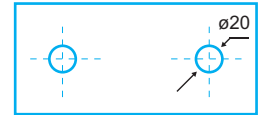

DIVIDING PANEL CUT-OUT

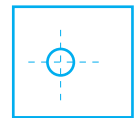

TOP VIEW

