

# SHOWER SEALS ONLINE



**PRODUCT  
PROFILE**

**HINGES**



Architectural glass  
fittings and bathroom  
accessories

We have a strong focus on developing new products and as a testament to our innovation, we boast one of the most diverse and unique inventories in our field.

## OUR EFFORTS ARE GUIDED BY THE FOLLOWING THREE PRINCIPLES

### VALUE

Providing our customers with the products they need at a good price is just the beginning. By choosing to deal with us, our customers must receive extra value. To this end we offer technical support, training and software aimed at making the jobs of our customers easier.

### SERVICE

Prompt delivery isn't enough. By choosing to deal with us, our customers have earned a partner that goes the extra mile. In this spirit, we respond to our customers needs irrespective of what we have in stock.

### QUALITY

Reliability is a given. By choosing to deal with us, our customers deserve an attention to detail. That is why we worry about the small things like superior fixings and high grade gaskets.



We boast a range of stylish hinges, each created to combine top-quality solutions with visually stunning designs.

**SDH-801-90**



90° Full back hinge wall-mounted – four screws  
Glass thickness: 6 to 12mm toughen safety glass weighing up to 50kg  
Material: Brass  
Finish: Bright or satin chrome plated

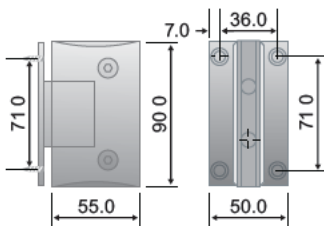
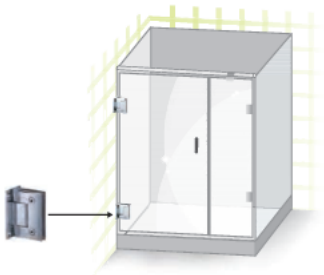

GLASS CUT OUT

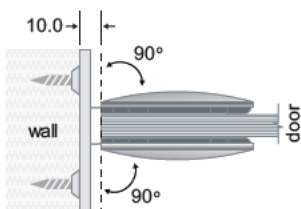
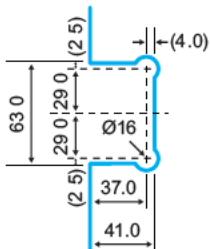

**SDH-801-90HP**



90° Half back hinge wall-mounted  
Glass thickness: 6 to 12mm toughen safety glass weighing up to 50kg  
Material: Brass  
Finish: Bright or satin chrome plated

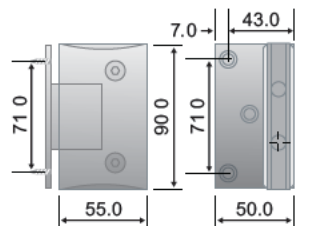
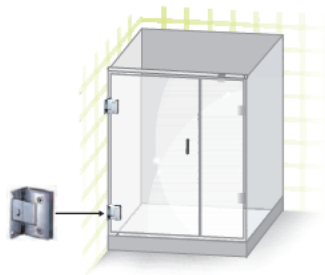

GLASS CUT OUT

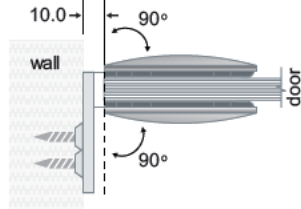
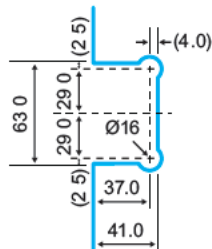

**SDH-801-360**



360° Floor-mounted pivot hinge – two screws  
Glass thickness: 6 to 12mm toughen safety glass weighing up to 50kg  
Material: Brass  
Finish: Bright or satin chrome plated

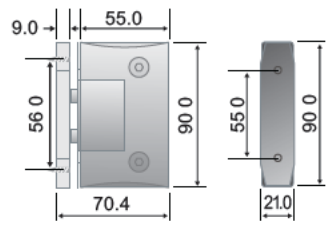
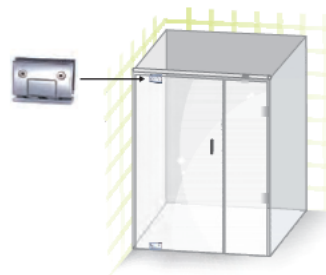

GLASS CUT OUT

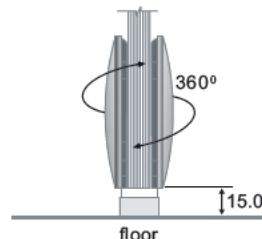
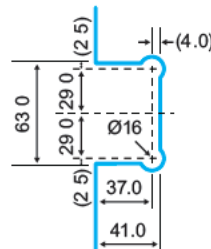

**H100T**



Glass-to-glass tee hinge  
Glass thickness: 6 to 12mm toughen safety glass weighing up to 50kg  
Material: Brass  
Finish: Bright chrome plated

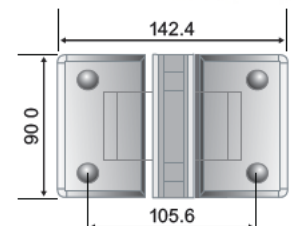
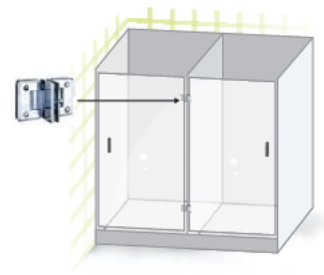

GLASS CUT OUT FIXED PANEL

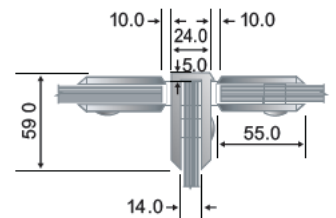
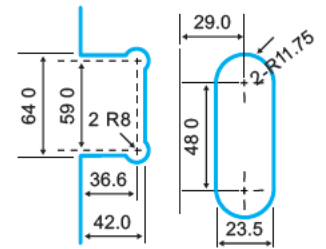

SDH-802-180



180° Glass-to-glass hinge  
Glass thickness: 6 to 12mm toughen safety glass weighing up to 50kg  
Material: Brass  
Finish: Bright or satin chrome plated

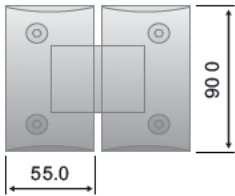
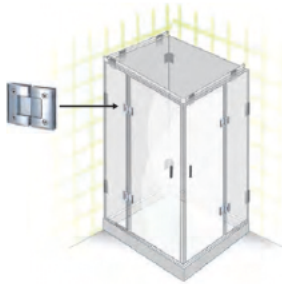

GLASS CUT OUT

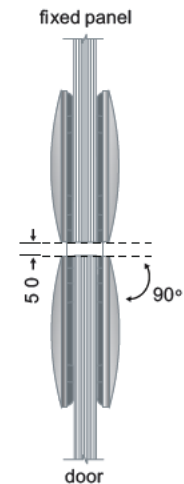
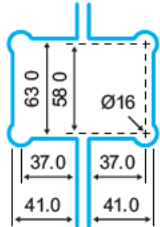

SDH-802-90



90° Glass-to-glass hinge  
Glass thickness: 6 to 12mm toughen safety glass weighing up to 50kg  
Material: Brass  
Finish: Bright or satin chrome plated

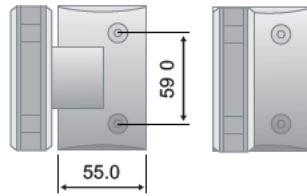
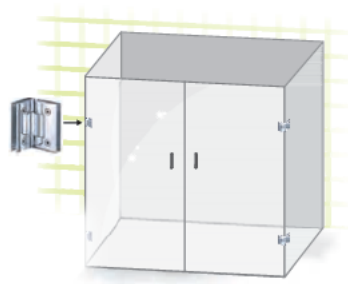

GLASS CUT OUT

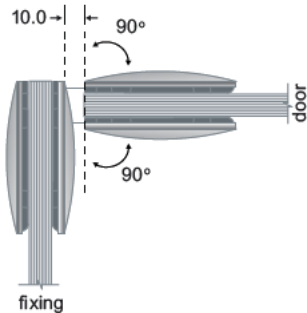
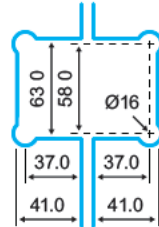

SDH-802-135



135° Glass-to-glass hinge  
Glass thickness: 6 to 12mm toughen safety glass weighing up to 50kg  
Material: Brass  
Finish: Bright or satin chrome plated

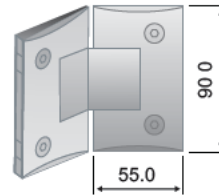
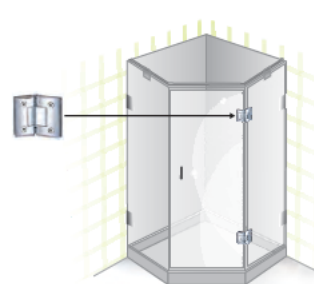

GLASS CUT OUT

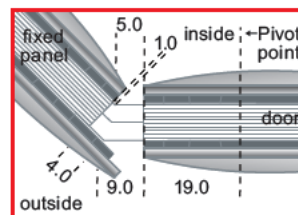
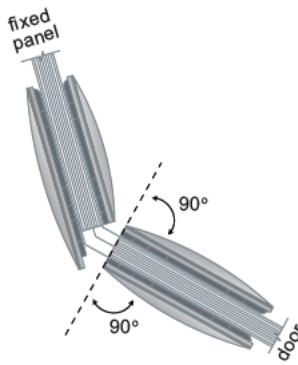
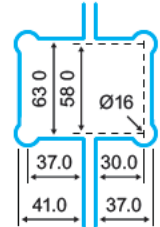

Deduction calculated for 8mm glass.

SDH-802-135EC



135° Glass-to-glass hinge equal cut-out  
Glass thickness: 6 to 12mm toughen safety glass weighing up to 50kg  
Material: Brass  
Finish: Bright chrome plated

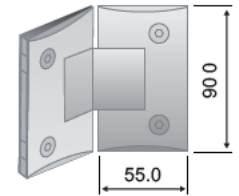
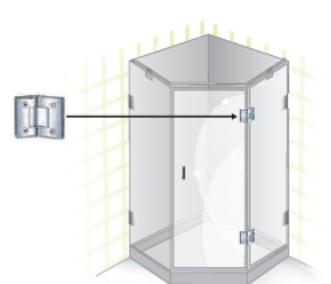

GLASS CUT OUT

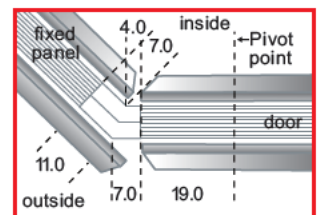
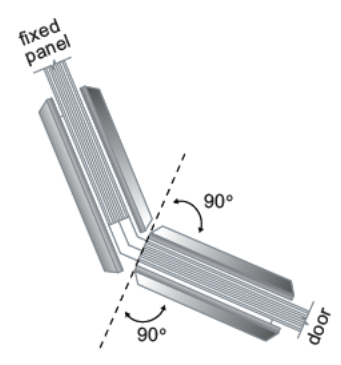
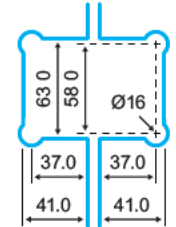

Deduction calculated for 8mm glass.



SDH-101-135



135° Half plate hinge  
wall-mounted – three  
screws (bevel shape)  
Glass thickness: 6 to  
12mm toughen safety  
glass weighing up to 50kg  
Material: Brass  
Finish: Bright or satin  
chrome plated

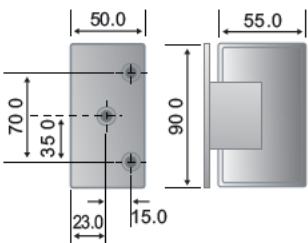

GLASS CUT OUT

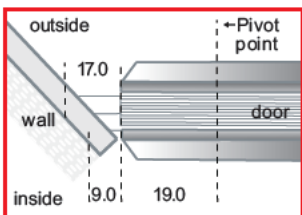
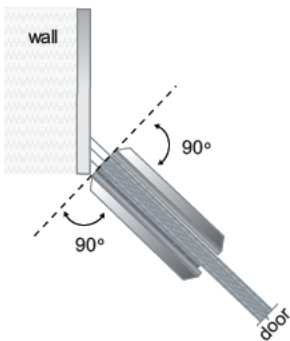
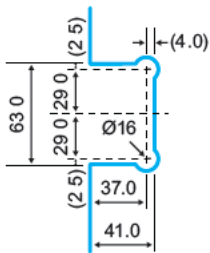

Deduction calculated for 8mm glass.

GDH-602



Small wall-to-glass hinge  
Glass thickness: 6mm  
toughen safety glass  
weighing up to 25kg  
Material: Brass  
Finish: Bright chrome  
plated

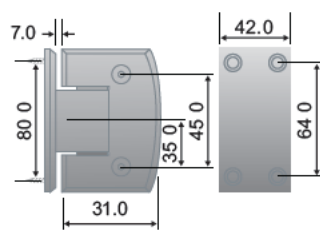

GLASS CUT OUT

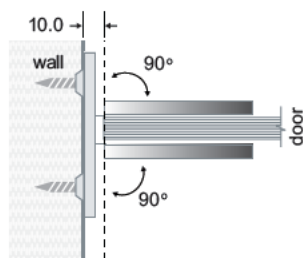
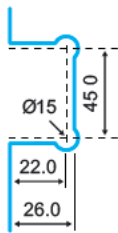

GDH-603



180° Wall-to-glass hinge  
Glass thickness: 6mm  
toughen safety glass  
weighing up to 25kg  
Material: Brass  
Finish: Bright chrome  
plated

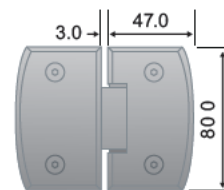

PANEL CUT OUT DOOR CUT OUT

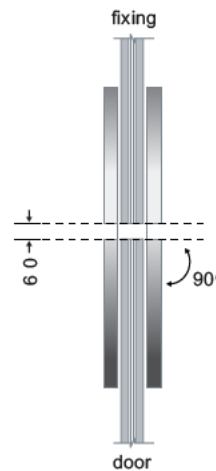
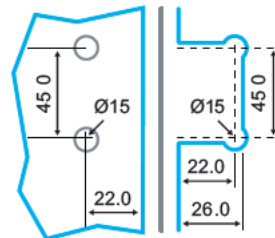

GDH-604



135° Glass-to-glass hinge  
Glass thickness: 6mm  
toughen safety glass  
weighing up to 25kg  
Material: Brass  
Finish: Bright chrome  
plated

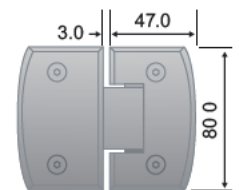

PANEL CUT OUT DOOR CUT OUT

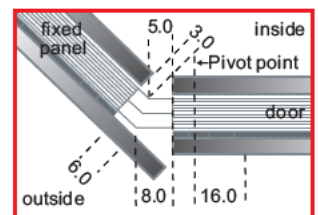
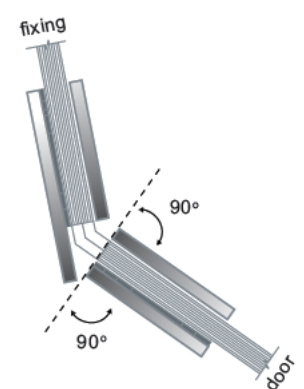
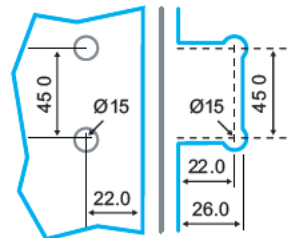

Deduction calculated for 6mm glass.



**S.S.O offers an extensive range of shower enclosure and bathroom accessories, with designs to suit every preference.**

**SDH-108-360**



180° Glass-to-glass pivot hinge (bevel shape)  
Glass thickness: 6 to 12mm toughen safety glass weighing up to 50kg  
Material: Brass  
Finish: Bright chrome plated

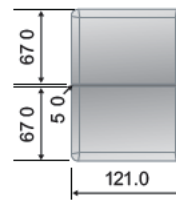
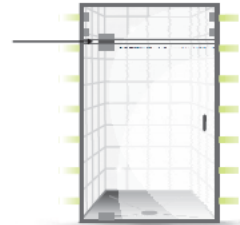

**GLASS CUT OUT**

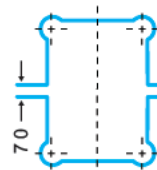
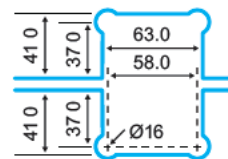

**SDH-104-360**



360° Floor-mounted pivot hinge – two screws (bevel shape)  
Glass thickness: 6 to 12mm toughen safety glass weighing up to 50kg  
Material: Brass  
Finish: Bright chrome plated

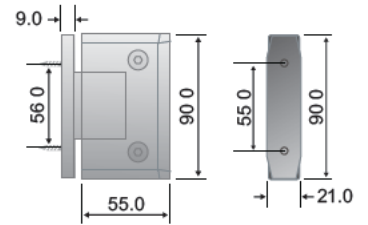

**GLASS CUT OUT**

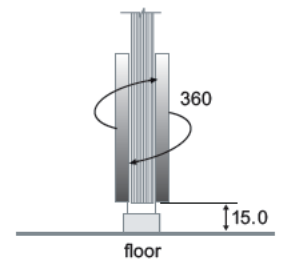
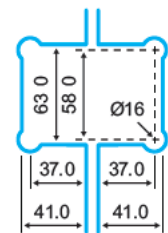

STM-GGH-180L (or R)



180° Rising self-closing glass-to-glass hinge left  
Material: Brass  
Finish: Bright chrome plated

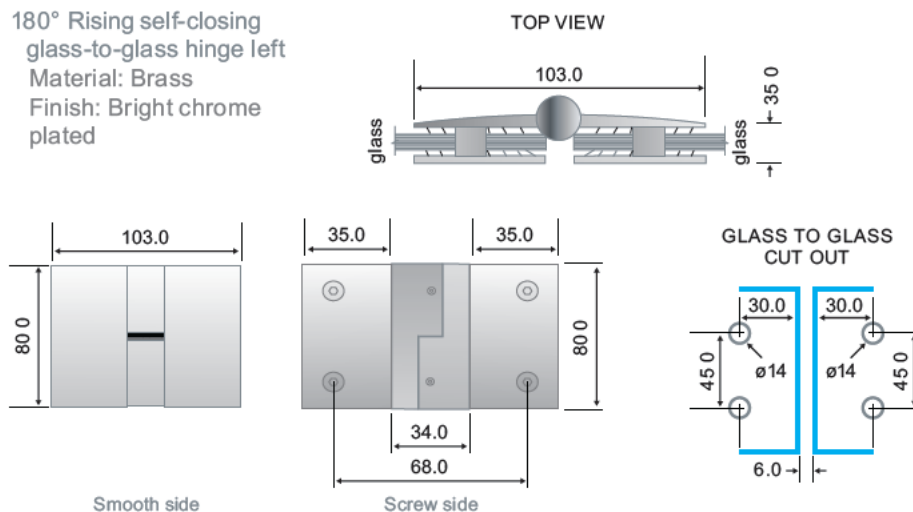

STM-WGH-90L (and R)



Self-rising wall-to-glass 90° hinge left (and right available)  
Glass thickness: 6 to 12mm toughen safety glass weighing up to 50kg  
Material: Brass  
Finish: Bright chrome plated

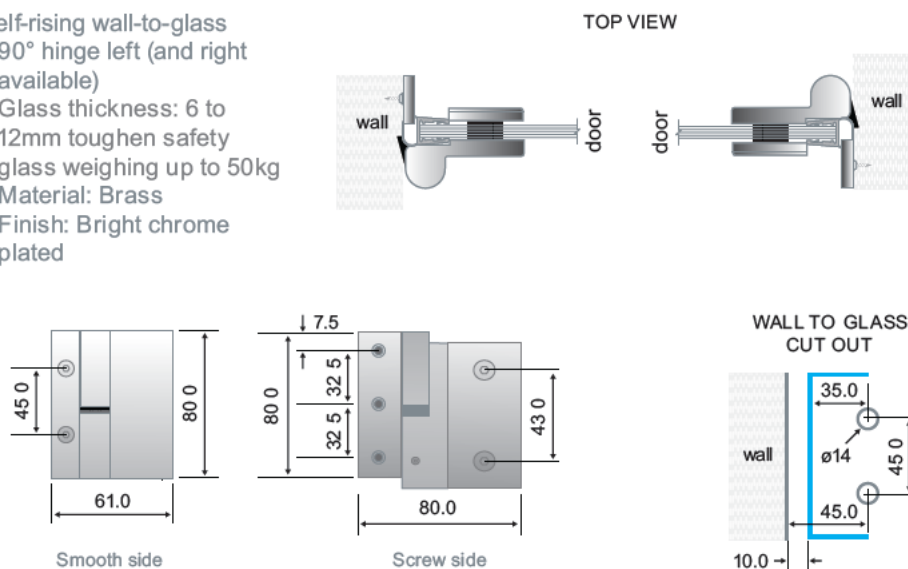

**NB: Swivel hinges on horizontal axis only. The pin must always be facing upwards.**

**Left wall (opening inwards)**

**WALL-TO-GLASS**

Right-hand screw side facing outwards

**GLASS-TO-GLASS**

Left-hand smooth side facing outwards

**Right wall (opening inwards)**

**WALL-TO-GLASS**

Left-hand screw side facing outwards

**GLASS-TO-GLASS**

Right-hand smooth side facing outwards



Smooth side

**Left wall (opening outwards)**

**WALL-TO-GLASS**

Left-hand smooth side facing outwards

**GLASS-TO-GLASS**

Right-hand screw side facing outwards

**Right wall (opening outwards)**

**WALL-TO-GLASS**

Right-hand smooth side facing outwards

**GLASS-TO-GLASS**

Left-hand screw side facing outwards



Screw side

